

HS25-CI HS50-CI

Raising the mounting plate
Hochsetzen der Montageplatte
Rehaussement de la platine de montage

06/91 AWA32-573

1

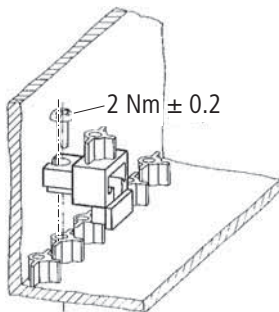

2

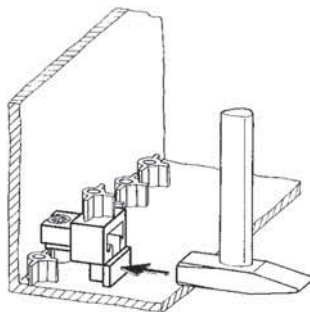

3

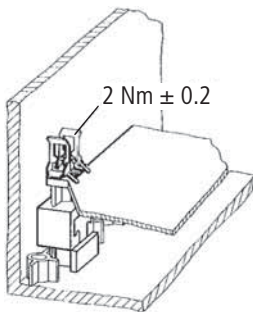

Fitting components above the mounting plate – Überbauen der Montageplatte –
Montage en deux plans (platine et rail)

1

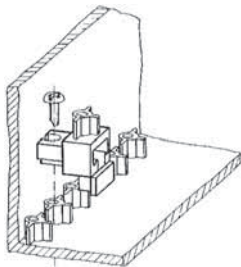

2

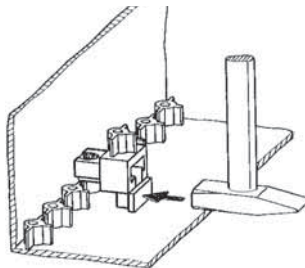

3

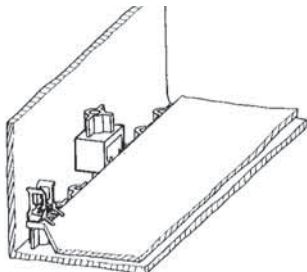

4

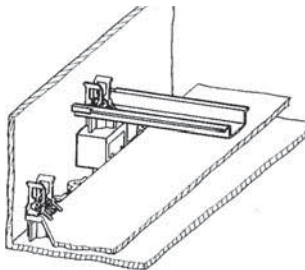

06/91 AWA32-573